

DUCHATEAU

PICTURA

INSTALLATION GUIDE

DUCHATEAU

THANK YOU FOR CHOOSING DUCHATEAU.

We strongly recommend you utilize an experienced Finish Carpenter to ensure a successful installation. The right tools and knowledge are important to ensure beautiful results.

IMPORTANT:

BE SURE TO FULLY INSPECT SHIPMENT FOR ANY DAMAGE IMMEDIATELY UPON ARRIVAL PRIOR TO INSTALLATION. ANY DAMAGE MUST BE REPORTED IMMEDIATELY TO CUSTOMERSERVICE@DUCHATEAU.COM

WARNING:

IMPROPERLY INSTALLING DUCHATEAU WALL COVERINGS MAY RESULT IN VOIDING YOUR WARRANTY. PROTECT YOUR WARRANTY AND YOUR INVESTMENT, ALWAYS FASTEN AND GLUE DUCHATEAU WALL COVERINGS.

CONTENTS



















RECOMMENDED TOOLS

VERTICAL INSTALLATION

HORIZONTAL INSTALLATION

CEILING INSTALLATION

RECOMMENDED TOOLS

 <p>FLAT BLACK PAINT, TRAY AND PROTECTIVE FLOOR COVER</p>	 <p>BRUSH AND ROLLER</p>	 <p>BLACK TAPE</p>	 <p>LASER LEVEL OR LEVEL</p>	 <p>CHALK LINE</p>	 <p>CONSTRUCTION ADHESIVE AND APPLICATOR</p>
 <p>FINISH MITER SAW* WITH A HORIZONTAL CAPACITY OF 16"</p>	 <p>FINISH TABLE SAW*</p>	 <p>JIGSAW</p>	 <p>23 GAUGE NAIL GUN WITH NAILS</p>	 <p>18 GAUGE NAIL GUN WITH NAILS</p>	 <p>FLATHEAD SCREWS - OPTIONAL</p>
 <p>DRILL</p>	 <p>AIR COMPRESSOR</p>	 <p>COUNTERSINK BIT - IF USING FLATHEAD SCREWS</p>	 <p>STEP LADDER OR SCAFFOLD - IF NECESSARY</p>	 <p>RUBBER MALLET</p>	 <p>MEASURING TAPE, RULER AND SCORING KNIFE</p>

Our warranty does not cover damage resulting from the use of adhesive tape of any kind, for any period of time, on our finished surfaces. Use of adhesive tape or similar products may result in removal of the finish of the Wood Products.

VERTICAL INSTALLATION

PICTURA WALL PANEL INSTALLATION GUIDELINES

STEP 2

Measure the area where the Pictura panels will be installed. After obtaining the dimensions, lay the panels in a flat floor to do a pre-assembly and mark the cuts you will need.

TOOLS: CHALK LINE &
MEASURING TAPE

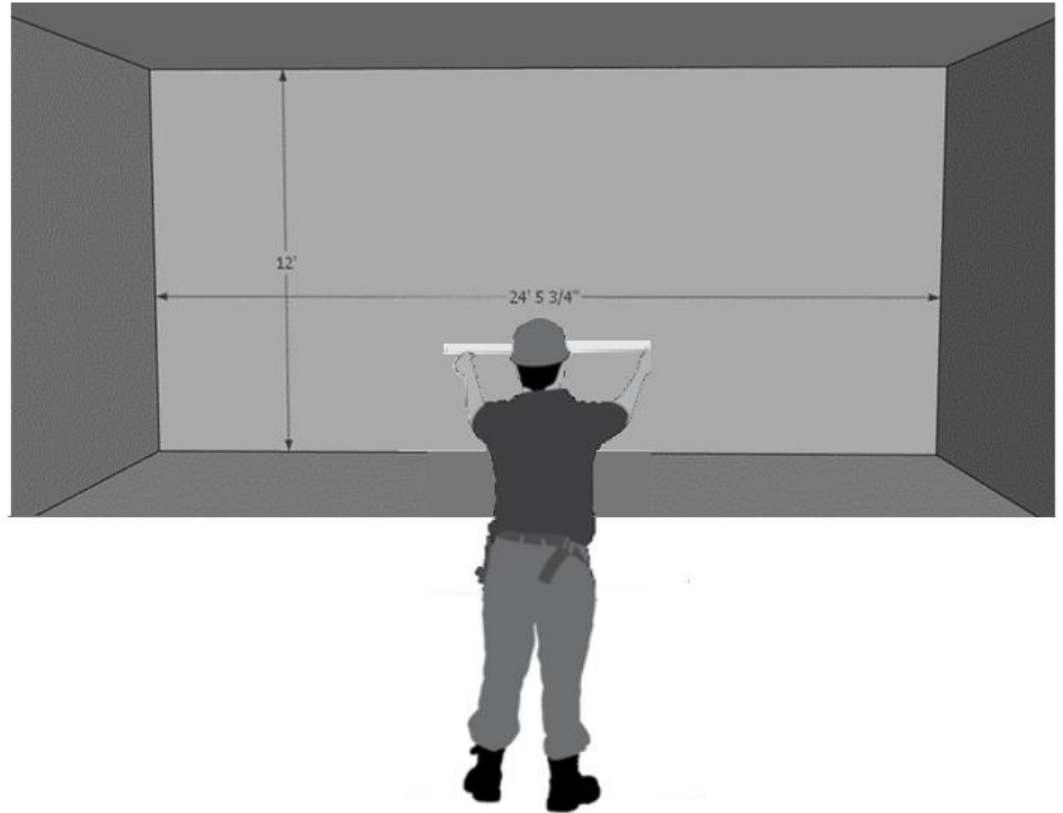

PICTURA WALL PANEL INSTALLATION GUIDELINES

STEP 3

Add adhesive on the back Pictura panel and place the initial panel at the starting point of the installation.

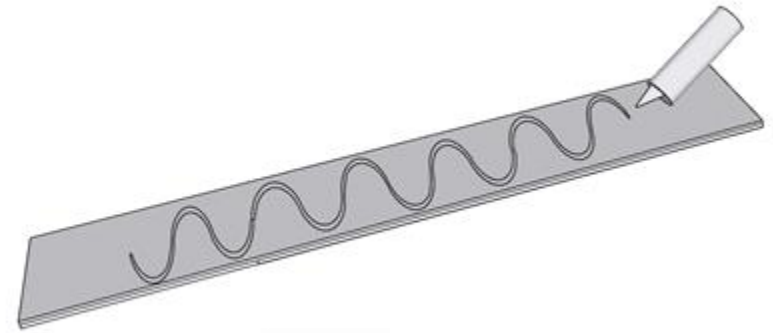

STEP 4

Apply pressure on the individual piece when nailing.

Using 18 Gauge Nails, nail along the panel, make sure you will be able to hide nails with the overlap of the next panel.

When possible, do not nail on the face of the panel, try to nail the groove the panels to maintain the finished aesthetic of the wall covering.

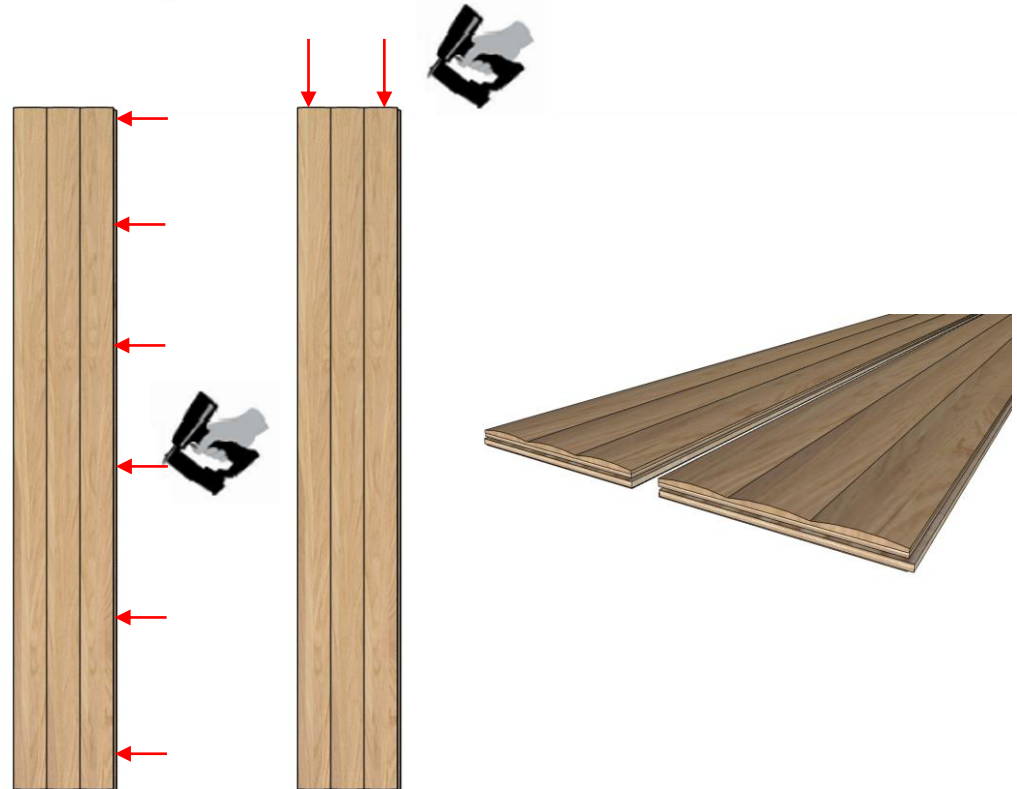

PICTURA WALL PANEL INSTALLATION GUIDELINES

STEP 5

It is recommended to define and mark initial cuts before starting the installation.

Assemblies can start from left to right or right to left, you just need to rotate the panel to make sure the next panel will be able to overlap the nails of the initial panel.



STEP 6

Affix the second piece with glue and nails overlapping the from the previous panel. When starting the next row, use a rubber mallet for adjustments while the glue is still wet, ensuring the piece fits snugly into the overlap. Verify that there are no gaps between the pieces.

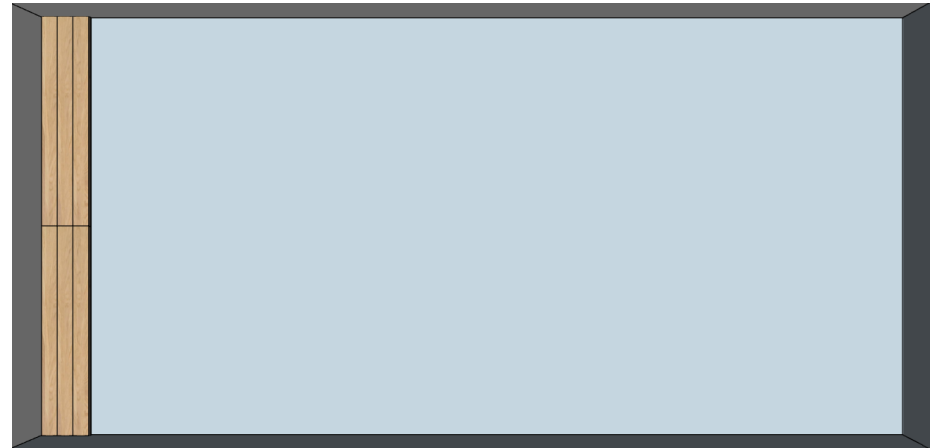

PICTURA WALL PANEL INSTALLATION GUIDELINES

STEP 7

Repeat this fastening process across the wall, ensuring careful attention to the joints, fixation with the nails and alignment.

STEP 8

Make sure to measure carefully and cut any panels to fit as you approach the end of the wall.



PICTURA WALL PANEL INSTALLATION GUIDELINES

STEP 9

To cut the panels, mark the measurements on both ends of the panel. When cutting lengthwise, use a table saw with a guide for better cut precision.



STEP 10

To finalize, place the cut pieces on the wall from the bottom moving upwards, attaching each panel with glue and nails.

The panels can be complemented with available moldings:

- Edge Trim
- Baseboard
- Exterior Corner
- Inside Corner



HORIZONTAL INSTALLATION

PICTURA WALL PANEL INSTALLATION GUIDELINES

STEP 1

Ensure your application wall is level and plumb. If discrepancies in height or width exist, adjust your layout accordingly.

Correct any surface irregularities in the installation area that could affect panel placement.

Pictura wall panels are suitable for most flat, smooth surfaces, including plywood and gypsum.

Like all natural wood, Pictura may expand and contract. To accommodate this, paint the wall behind the panels in flat black. This helps minor gaps from expansion or contraction appear as shadows, ensuring a seamless look.

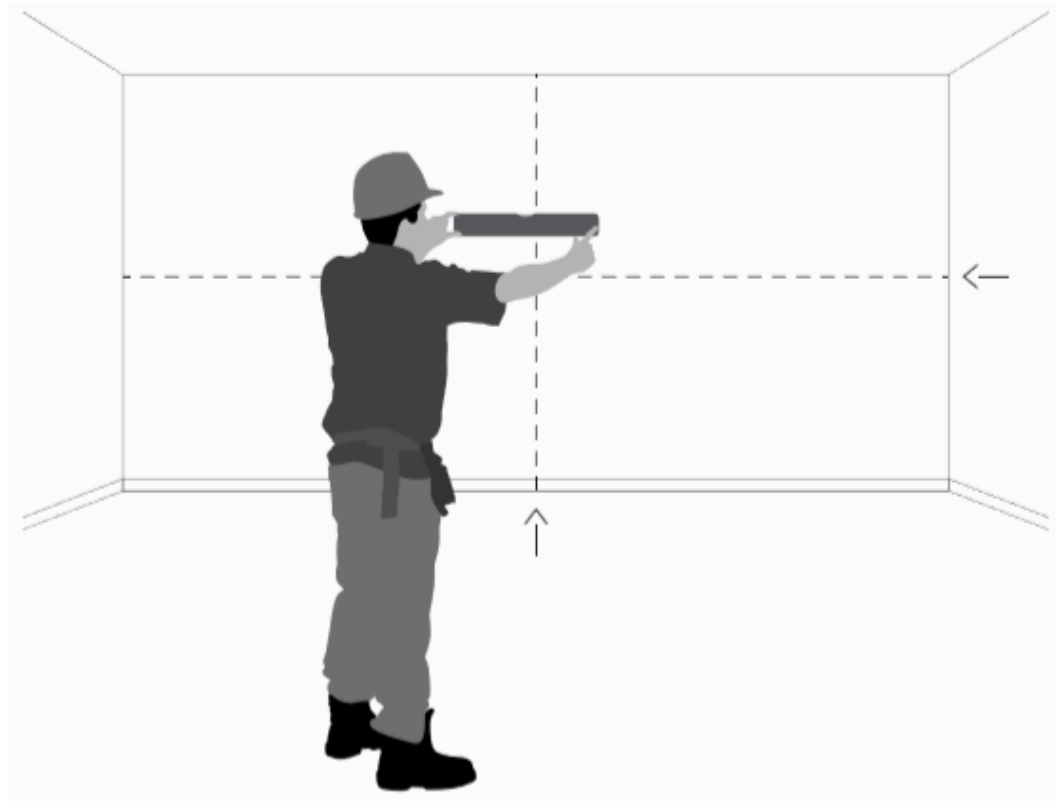

PICTURA WALL PANEL INSTALLATION GUIDELINES

STEP 2

Measure the area where the Pictura panels will be installed. After obtaining the dimensions, lay the panels in a flat floor to do a pre-assembly and mark the cuts you will need.

TOOLS: CHALK LINE & MEASURING TAPE

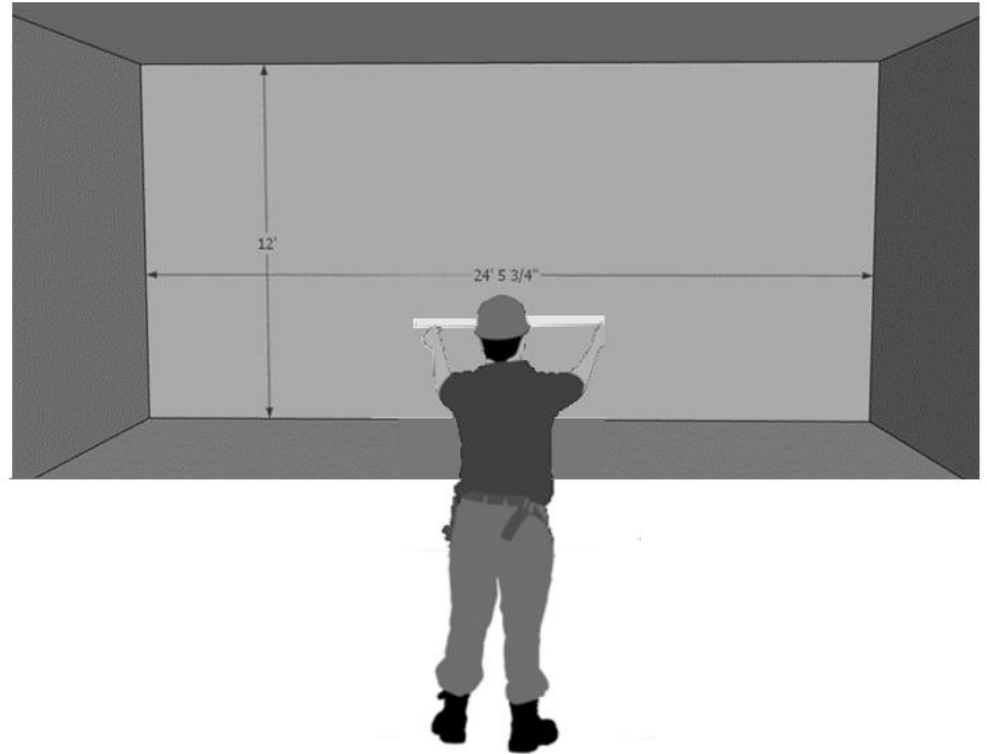

PICTURA WALL PANEL INSTALLATION GUIDELINES

STEP 3

Add adhesive on the back panel and place the initial panel at the starting point of the installation.

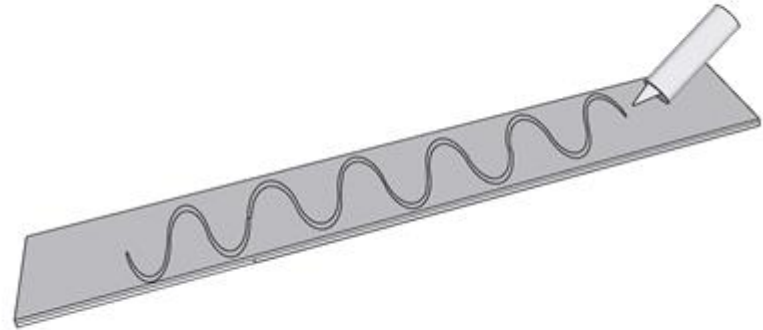

STEP 4

Apply pressure on the individual piece when nailing.

Using 18 Gauge Nails, nail along the panel, make sure you will be able to hide nails with the overlap of the next panel.

When possible, do not nail on the face of the panel, try to nail the groove the panels to maintain the finished aesthetic of the wall covering.

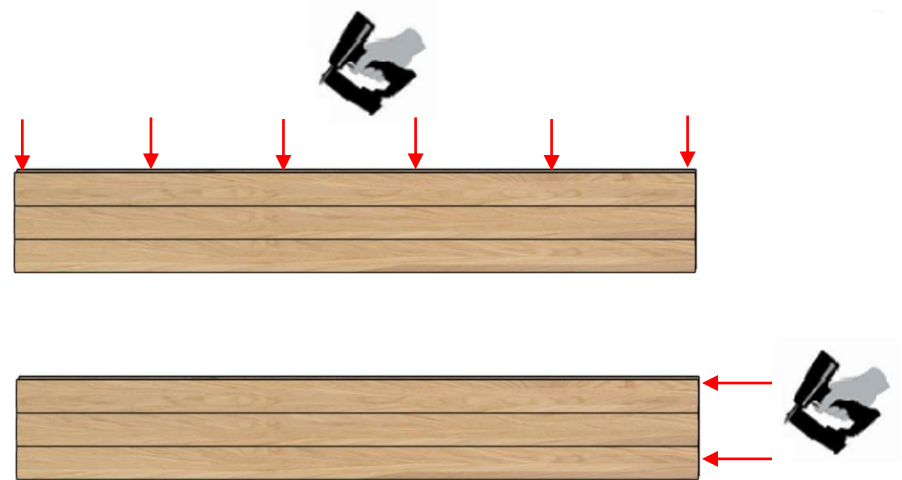

PICTURA WALL PANEL INSTALLATION GUIDELINES

STEP 5

It is recommended to define and mark initial cuts, before starting the installation.

Assemblies can start from Bottom to Top or Top to Bottom, you just need to rotate the panel to make sure the next panel will be able to overlap the nails of the initial panel.

STEP 6

Affix the second piece with glue and nails overlapping from the previous panel. When starting the next row, use a rubber mallet for adjustments while the glue is still wet, ensuring the piece fits snugly into the groove. Verify that there are no gaps between the pieces.

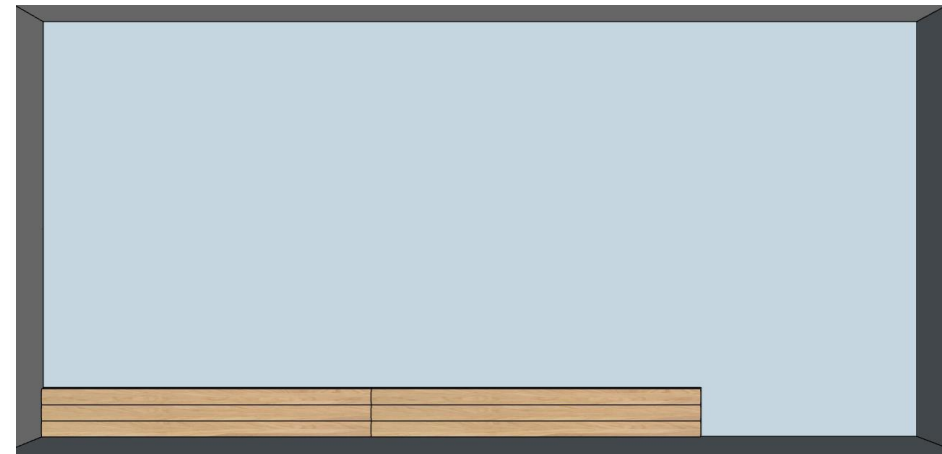
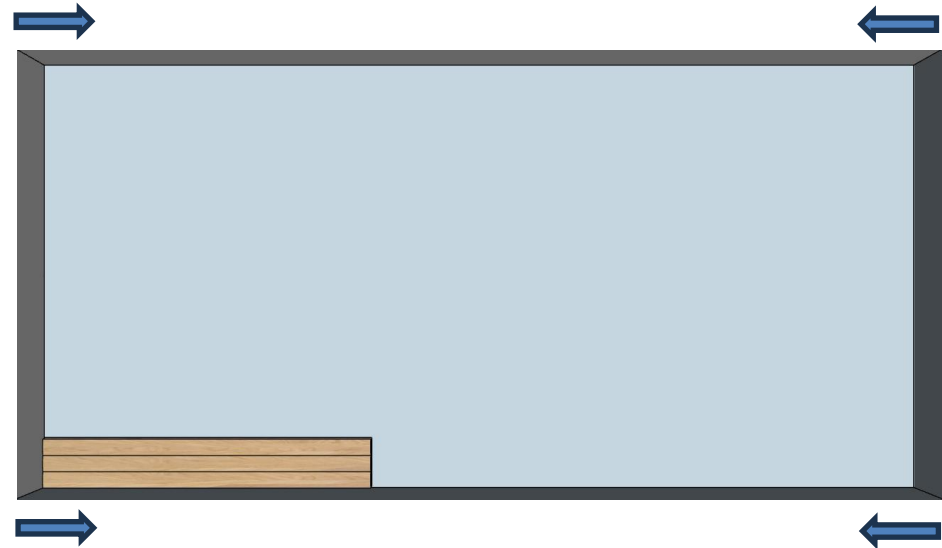

PICTURA WALL PANEL INSTALLATION GUIDELINES

STEP 7

To cut the panels, mark the measurements on both ends of the panel. When cutting lengthwise, use a table saw with a guide for better cut precision.

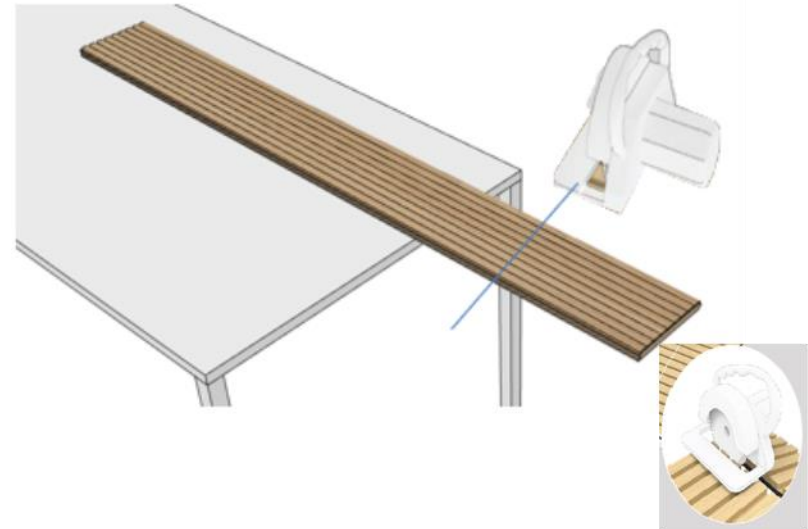

STEP 8

Affix the next piece with glue and nails, use a rubber mallet for adjustments while the glue is still wet. Verify that there are no gaps between the pieces.



PICTURA WALL PANEL INSTALLATION GUIDELINES

STEP 9

Place the next piece to continue the pattern. For the assembly, place the piece using the overlap fixed with nails, then slide the overlap and adjust with a rubber mallet.

STEP 10

To complete the line, you must use the piece that you previously cut.

Make sure each line you complete is aligned.



PICTURA WALL PANEL INSTALLATION GUIDELINES

STEP 11

Repeat this fastening process across the wall, ensuring careful attention to the joints, fixation with the nails and alignment.

STEP 12

Make sure to measure carefully and cut any panels to fit as you approach the end of the wall.



PICTURA WALL PANEL INSTALLATION GUIDELINES

STEP 13

To cut the panels you must mark the measurements at the two ends of the panel.

Care should be taken when cutting the pieces lengthwise, use a table saw with a guide.

STEP 14

To finalize, place the cut pieces from the bottom moving upwards, attaching each panel with glue and nails.

The panels can be complemented with available moldings:

- Edge Trim
- Baseboard
- Exterior Corner
- Inside Corner

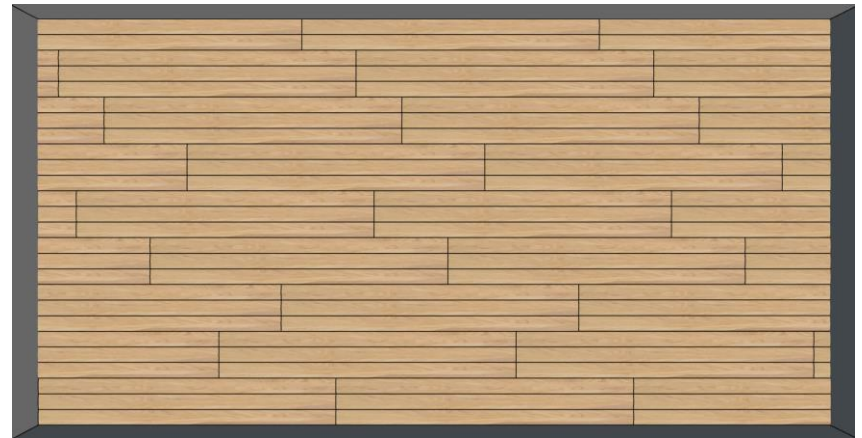

CEILING INSTALLATION

PICTURA WALL PANEL INSTALLATION GUIDELINES

STEP 1

Ensure your application wall is level and plumb. If discrepancies in height or width exist, adjust your layout accordingly.

Correct any surface irregularities in the installation area that could affect panel placement.

Pictura wall panels are suitable for most flat, smooth surfaces, including plywood and gypsum.

Like all natural wood, Pictura may expand and contract. To accommodate this, paint the wall behind the panels in flat black. This helps minor gaps from expansion or contraction appear as shadows, ensuring a seamless look.

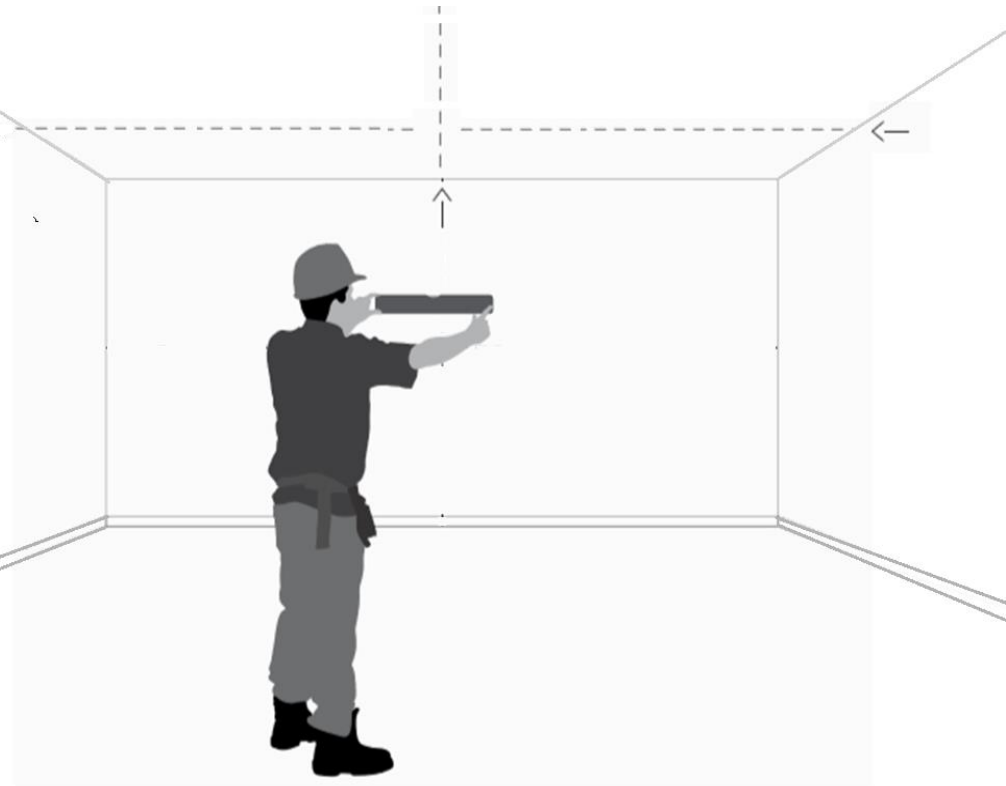

PICTURA WALL PANEL INSTALLATION GUIDELINES

STEP 2

Measure the area where the Pictura panels will be installed. After obtaining the dimensions, lay the panels in a flat floor to do a pre-assembly and mark the cuts you will need.

TOOLS: CHALK LINE & MEASURING TAPE

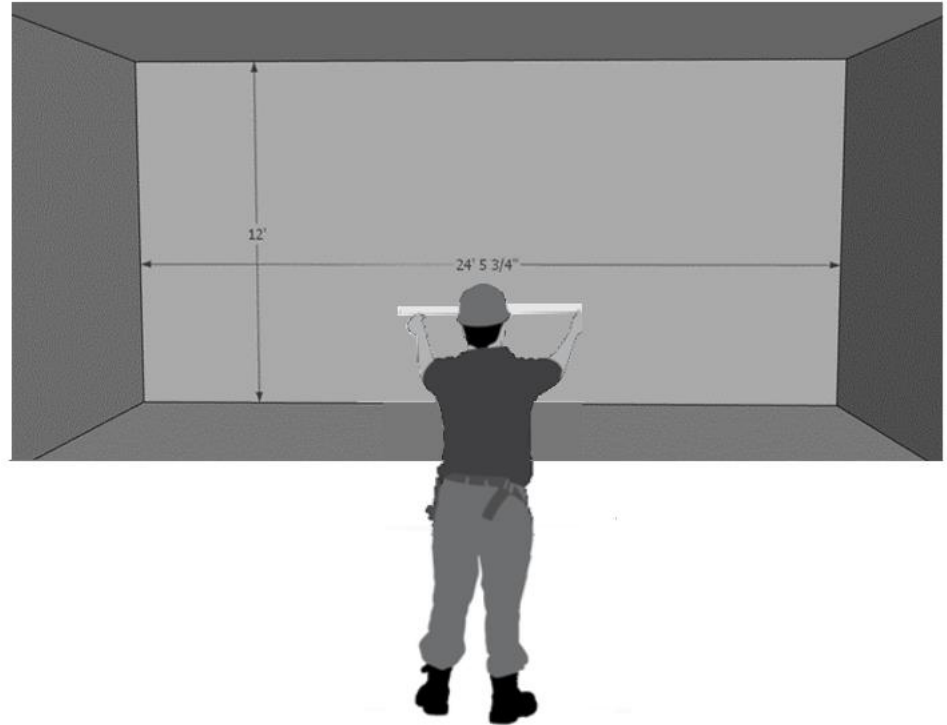

PICTURA WALL PANEL INSTALLATION GUIDELINES

STEP 3

Add adhesive on the back of the Pictura panel and place the initial panel at the starting point of the installation.

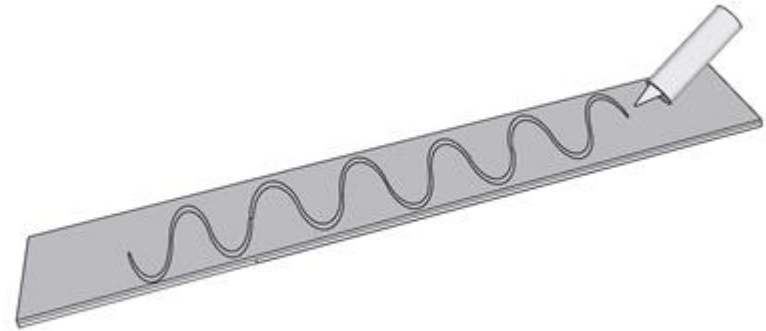

STEP 4

Apply pressure on the individual piece when nailing.

Using 18 Gauge Nails, nail along the panel, make sure you will be able to hide nails with the overlap of the next panel.

When possible, do not nail on the face of the panel, try to nail the groove the panels to maintain the finished aesthetic of the wall covering.

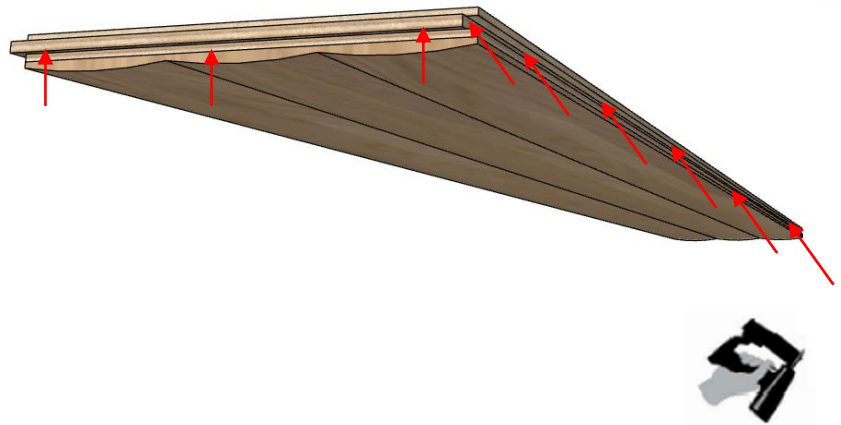

PICTURA WALL PANEL INSTALLATION GUIDELINES

STEP 5

It is recommended to define and mark initial cuts, before starting the installation.

Assemblies can start from left to right or right to left, you just need to rotate the panel to make sure the next panel will be able to overlap the nails of the initial panel.

In a ceiling application, it is important to note the direction you want to go.

STEP 6

Affix the second piece with glue and nails overlapping from the previous panel. When starting the next row, use a rubber mallet for adjustments while the glue is still wet, ensuring the piece fits snugly into the overlap. Verify that there are no gaps between the pieces.

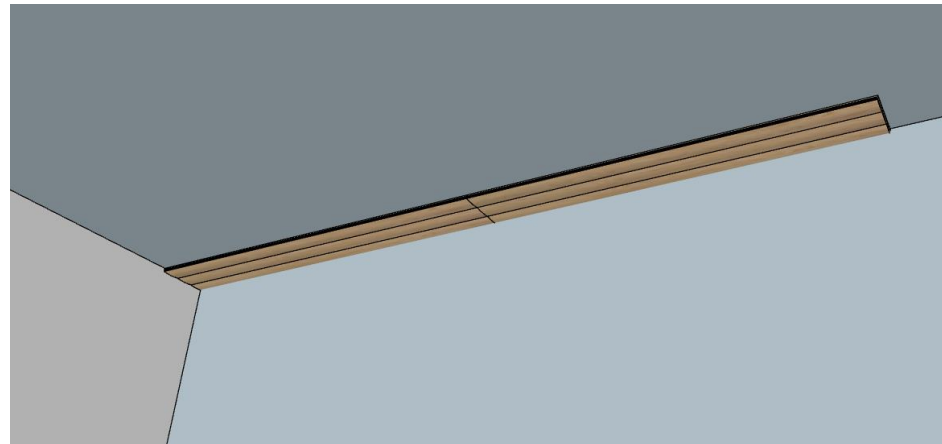
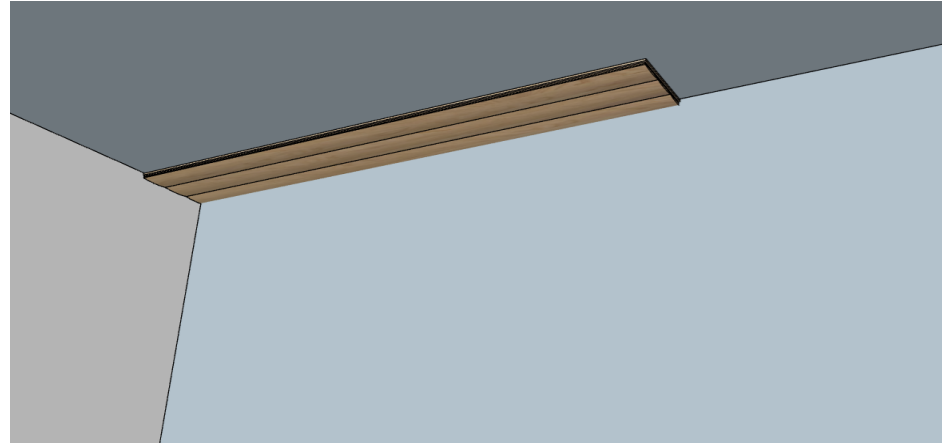

PICTURA WALL PANEL INSTALLATION GUIDELINES

STEP 7

To cut the panels, mark the measurements on both ends of the panel. When cutting lengthwise, use a table saw with a guide for better cut precision.

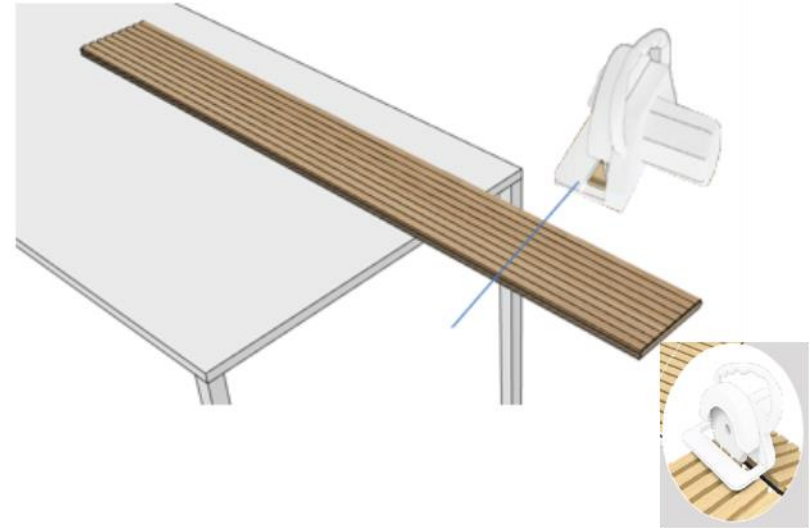

STEP 8

Affix the next piece with glue and nails, use a rubber mallet for adjustments while the glue is still wet. Verify that there are no gaps between the pieces.

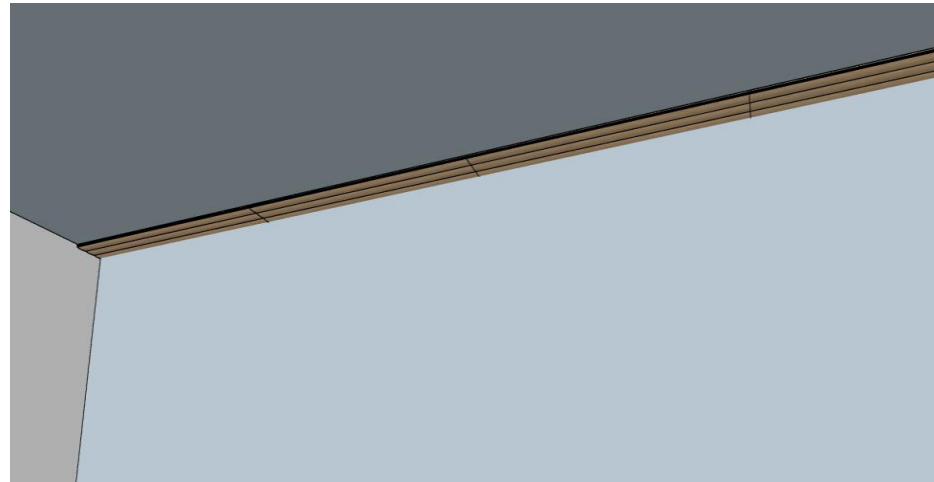

PICTURA WALL PANEL INSTALLATION GUIDELINES

STEP 9

Repeat this fastening process across the wall, ensuring careful attention to the joints, fixation with the nails and alignment.

STEP 10

Make sure to measure carefully and cut any panels to fit as you approach the end of the wall.

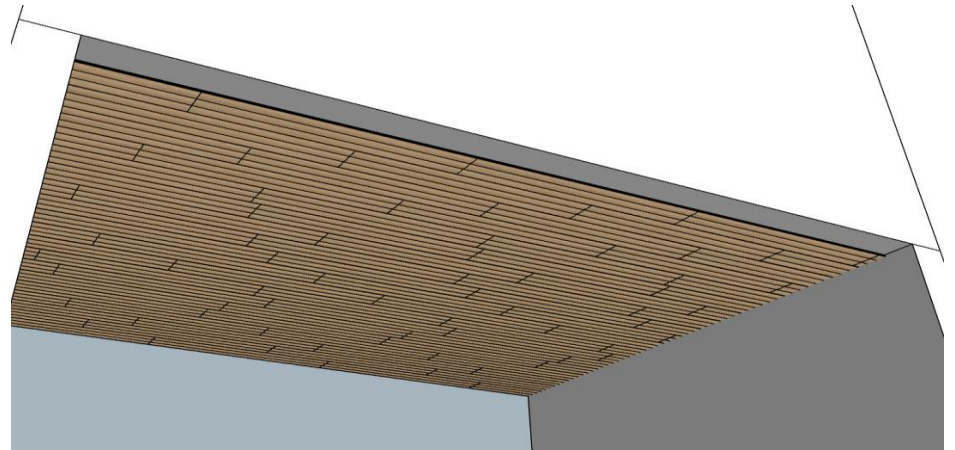
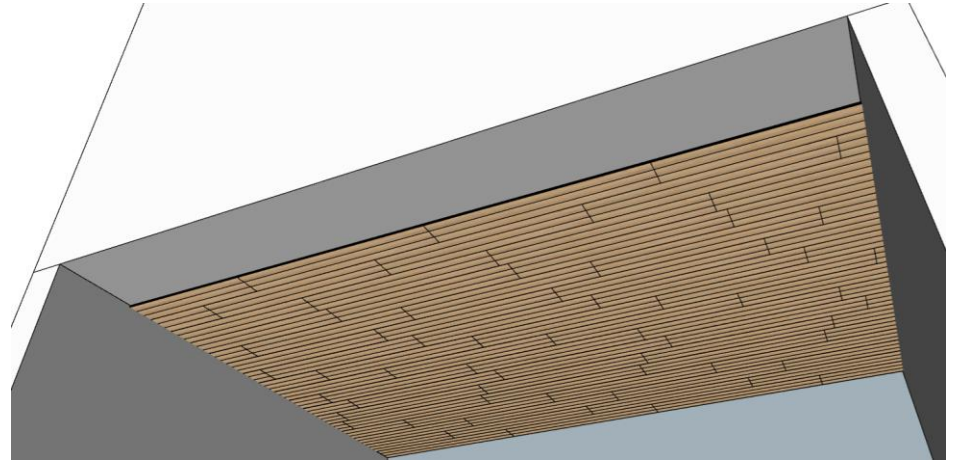

PICTURA WALL PANEL INSTALLATION GUIDELINES

STEP 11

To cut the panels you must mark the measurements at the two ends of the panel.

Care should be taken when cutting the pieces lengthwise, use a table saw with a guide.

STEP 12

To finalize, place the cut pieces from the bottom and moving upwards, attaching each panel with glue and nails.

The panels can be complemented with available moldings:

- Edge Trim
- Baseboard
- Exterior Corner
- Inside Corner

