

# **DUCHATEAU**

---

## **INTERVALS**

---

### **INSTALLATION GUIDE**

# DUCHATEAU

## THANK YOU FOR CHOOSING DUCHATEAU.

---

We strongly recommend you utilize an experienced Finish Carpenter to ensure a successful installation. The right tools and knowledge are important for beautiful results.

### **IMPORTANT:**

BEFORE INSTALLATION, FULLY INSPECT SHIPMENT FOR ANY DAMAGE UPON ARRIVAL. REPORT ANY DAMAGE IMMEDIATELY TO [CUSTOMERSERVICE@DUCHATEAU.COM](mailto:CUSTOMERSERVICE@DUCHATEAU.COM)

### **WARNING:**

IMPROPERLY INSTALLING DUCHATEAU WALL COVERINGS MAY RESULT IN VOIDING YOUR WARRANTY. ALWAYS FASTEN AND GLUE DUCHATEAU WALL COVERINGS TO PROTECT YOUR INVESTMENT.

# CONTENTS



















**RECOMMENDED TOOLS**

**VERTICAL INSTALLATION**

**HORIZONTAL INSTALLATION**

**CEILING INSTALLATION**

# RECOMMENDED TOOLS

 <p>FLAT BLACK PAINT, TRAY AND PROTECTIVE FLOOR COVER</p>	 <p>BRUSH AND ROLLER</p>	 <p>BLACK TAPE</p>	 <p>LASER LEVEL OR LEVEL</p>	 <p>CHALK LINE</p>	 <p>CONSTRUCTION ADHESIVE AND APPLICATOR</p>
 <p>FINISH MITER SAW* WITH A HORIZONTAL CAPACITY OF 16"</p>	 <p>FINISH TABLE SAW*</p>	 <p>JIGSAW</p>	 <p>23 GAUGE NAIL GUN WITH NAILS</p>	 <p>18 GAUGE NAIL GUN WITH NAILS</p>	 <p>FLATHEAD SCREWS - OPTIONAL</p>
 <p>DRILL</p>	 <p>AIR COMPRESSOR</p>	 <p>COUNTERSINK BIT - IF USING FLATHEAD SCREWS</p>	 <p>STEP LADDER OR SCAFFOLD - IF NECESSARY</p>	 <p>RUBBER MALLET</p>	 <p>MEASURING TAPE, RULER AND SCORING KNIFE</p>

---

# **VERTICAL INSTALLATION**

---

## INTERVALS WALL PANEL INSTALLATION GUIDELINES

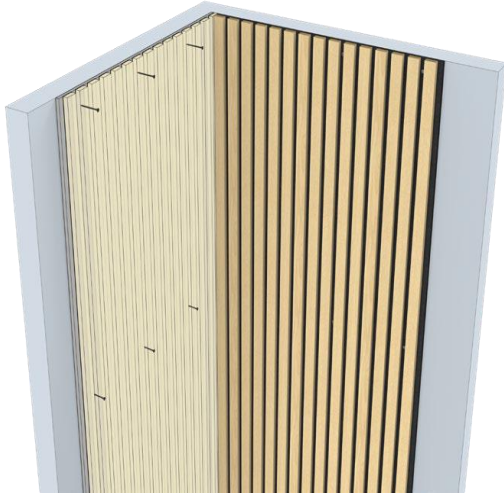

**A** Nail acoustic panels directly to the wall.

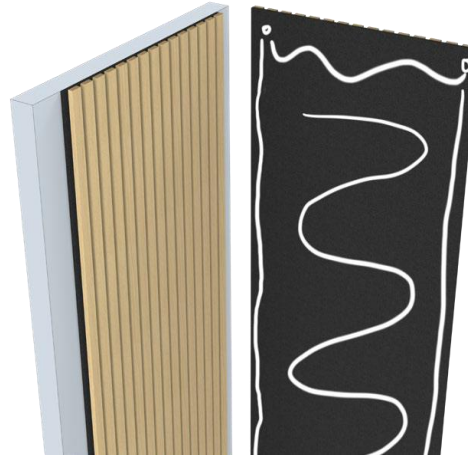

**B** Attach acoustic panels to the wall with nail-free glue.

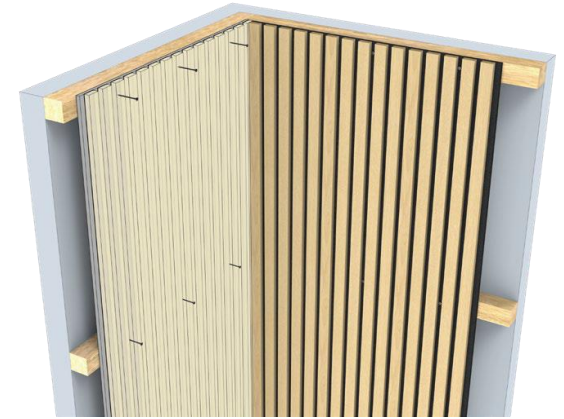

**C** Install fibreglass wool or rock wool between the battens to increase noise absorption.

# INTERVALS WALL PANEL INSTALLATION GUIDELINES

## STEP 1

Ensure your application wall is level and plumb. If discrepancies in height or width exist, adjust your layout accordingly.

Correct any surface irregularities in the installation area that could affect panel placement.

Intervals wall panels are suitable for most flat, smooth surfaces, including plywood and gypsum.

Like all natural wood, Intervals may expand and contract. To accommodate this, paint the wall behind the panels in flat back. This helps minor gaps from expansion or contraction appear as shadows, ensuring a seamless look.

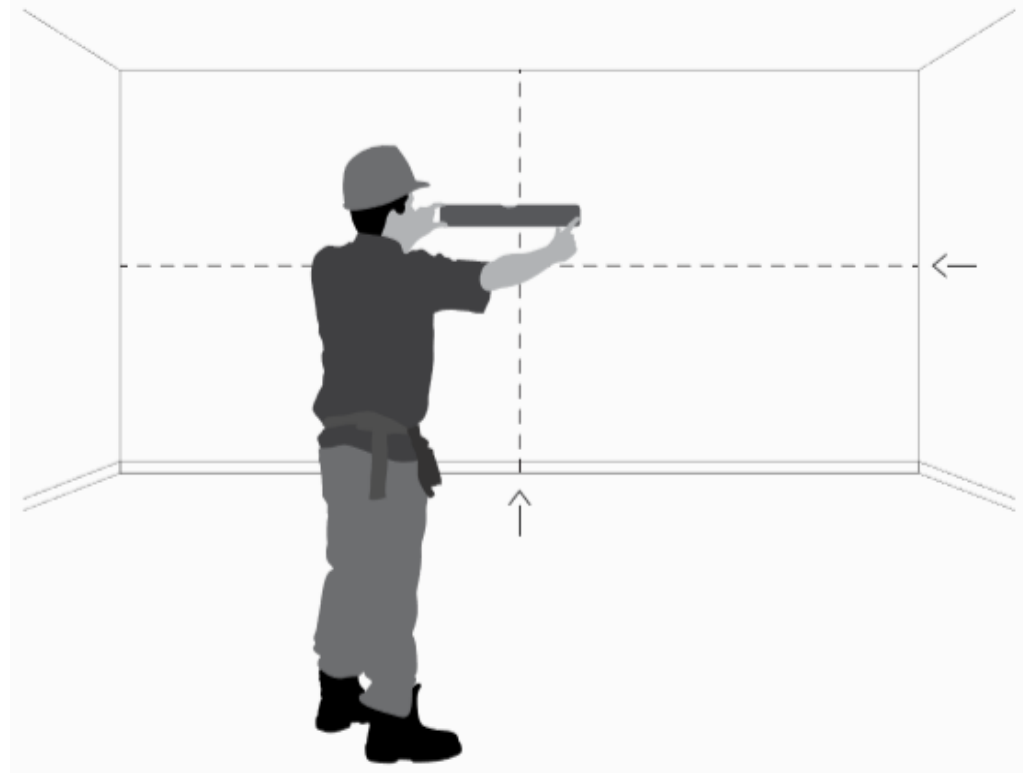

## INTERVALS WALL PANEL INSTALLATION GUIDELINES

### STEP 2

Measure the area where the Intervals panels will be installed. After obtaining the dimensions, lay the panels on a flat floor for pre-assembly and mark the cuts you will need.

TOOLS: CHALK LINE &  
MEASURING TAPE

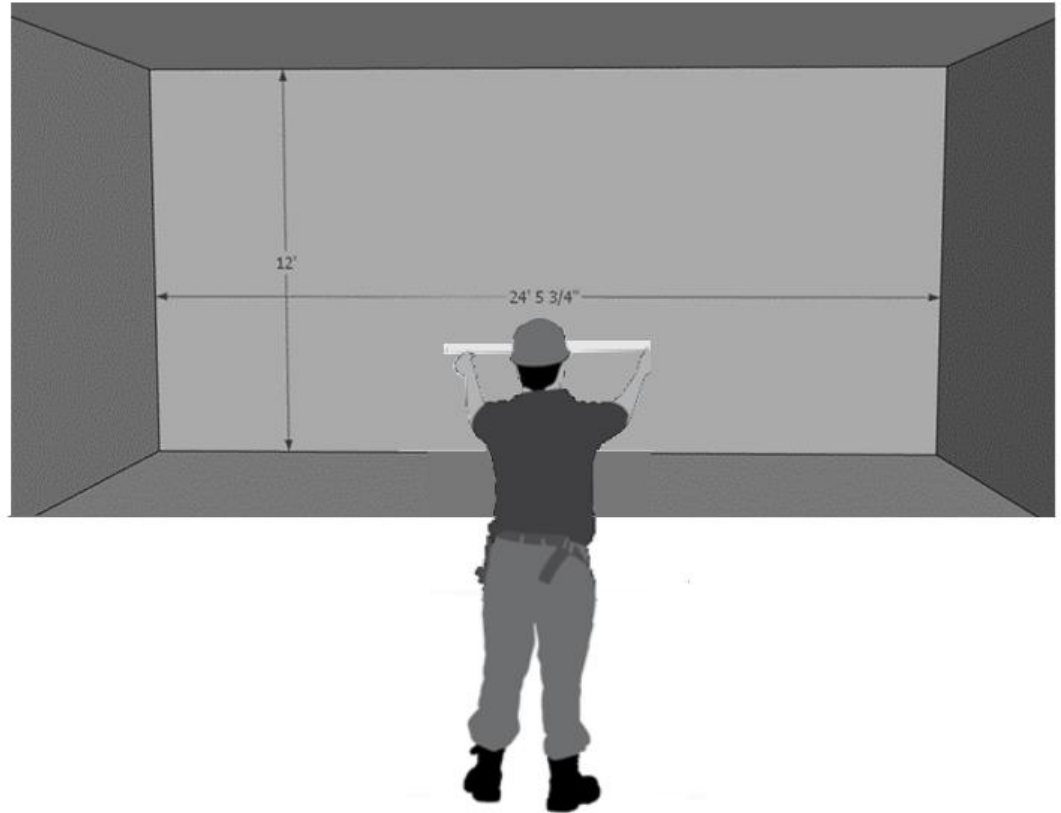

## INTERVALS WALL PANEL INSTALLATION GUIDELINES

### STEP 3

Peel off the protective paper from the adhesive. Be careful not to leave paper waste.

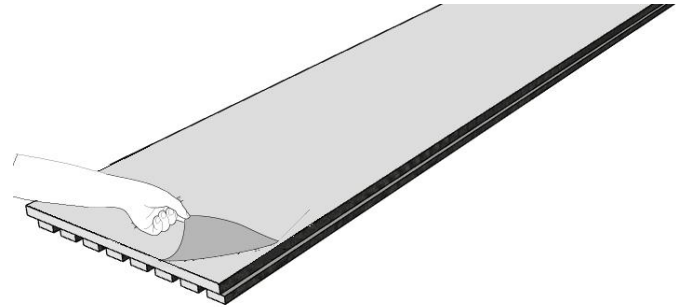

### STEP 4

Add adhesive on the back of the Intervals panel and place the initial panel at the starting point of the installation.

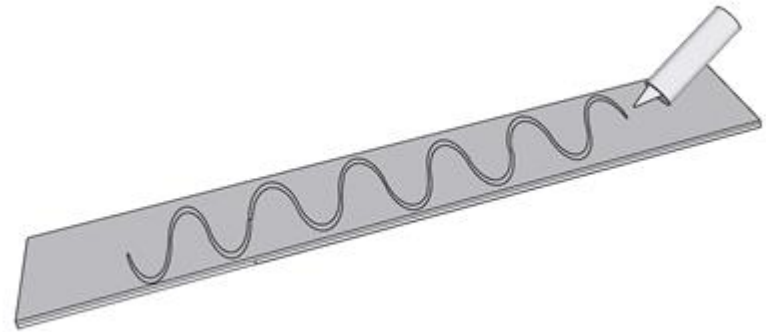

## INTERVALS WALL PANEL INSTALLATION GUIDELINES

### STEP 5

Apply pressure on the individual piece when nailing and screwing in.

Using 18 Gauge Nails and 1" black screws, nail along the panel, making sure you will be able to hide the black screws with the overlap of the next panel.

When possible, do not nail on the face of the slats, try to nail the felt or the lower edge of the veneer to maintain the finished aesthetic of the wall covering.

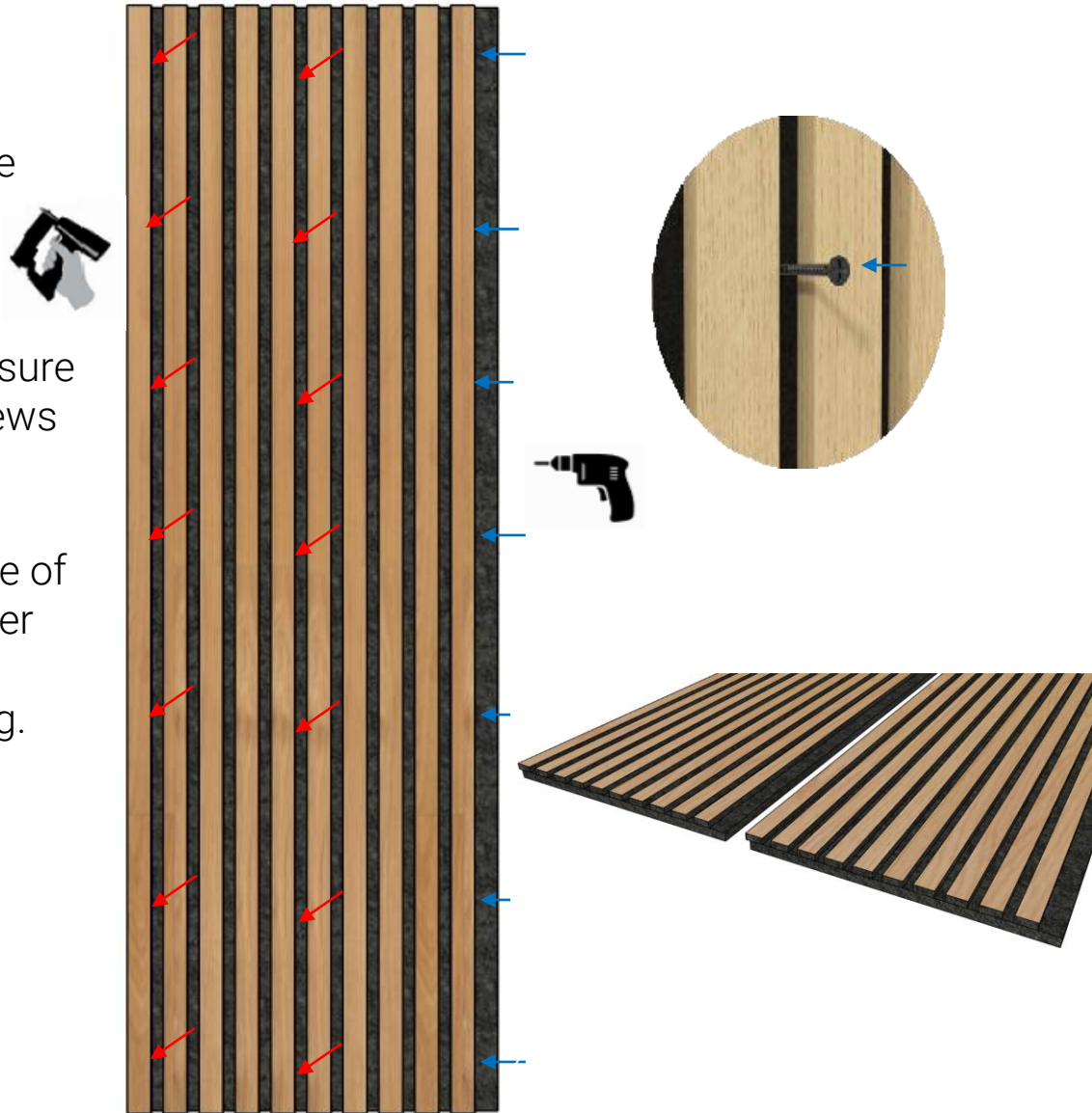

## INTERVALS WALL PANEL INSTALLATION GUIDELINES

### STEP 6

It is recommended to define and mark initial cuts before starting the installation.

Assemblies can start from left to right or right to left, you just need to rotate the panel to make sure the next panel will be able to overlap the screws of the initial panel.

### STEP 7

Affix the second piece with glue and nails overlapping the screws from the previous panel. When starting the next row, use a rubber mallet for adjustments while the glue is still wet, ensuring the piece fits snugly into the overlap. Verify that there are no gaps between the pieces.

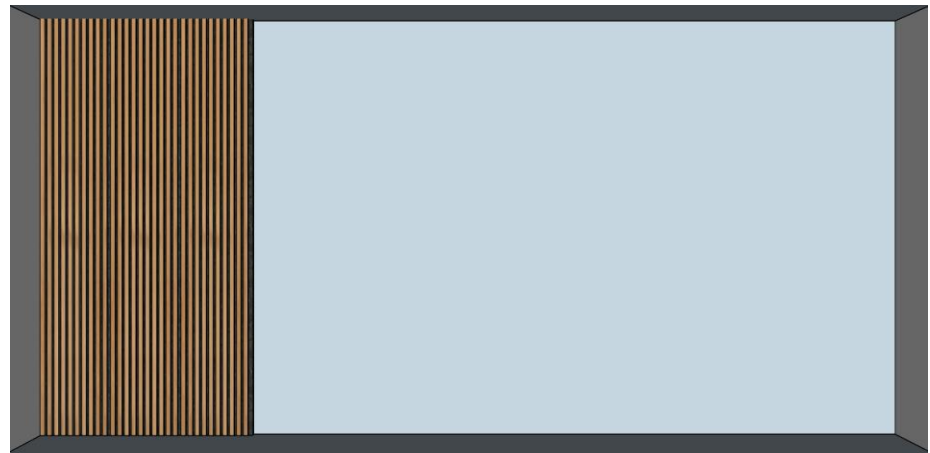

## INTERVALS WALL PANEL INSTALLATION GUIDELINES

### STEP 8

Repeat this fastening process across the wall, ensuring careful attention to the joints, fixation with the nails and screws, and alignment.

### STEP 9

Make sure to measure carefully and cut any panels to fit as you approach the end of the wall.

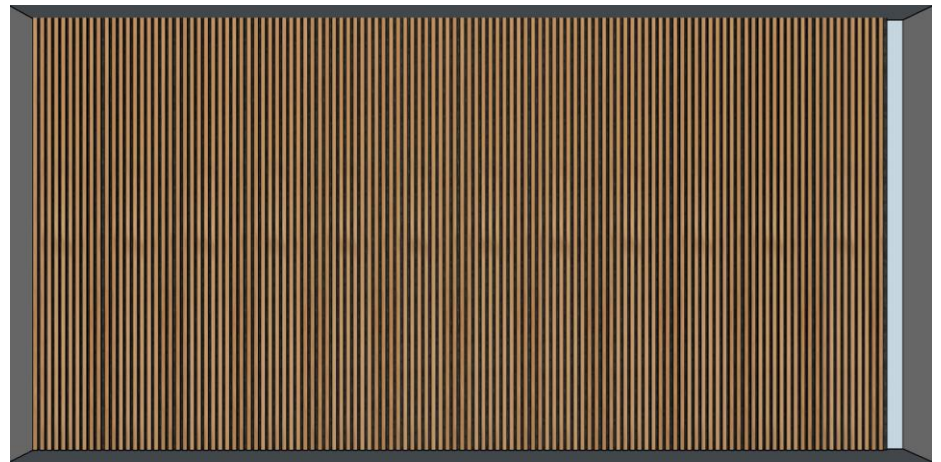
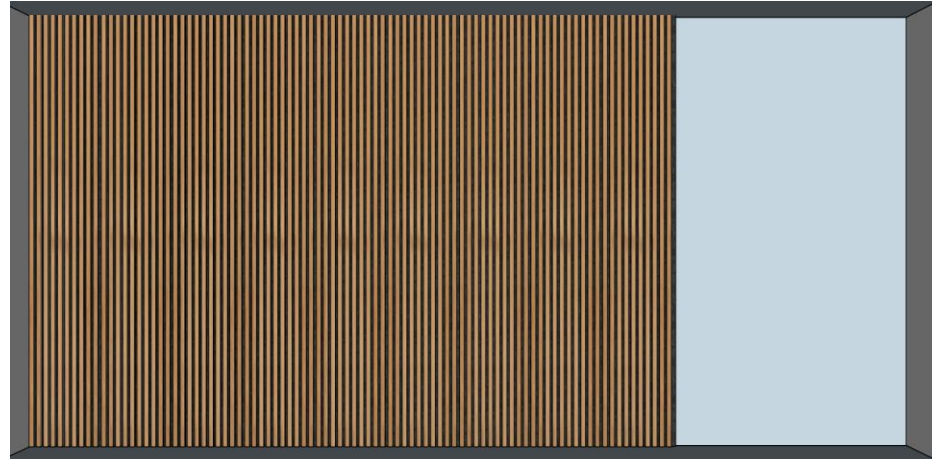

## INTERVALS WALL PANEL INSTALLATION GUIDELINES

### STEP 10

To cut the panels, mark the measurements on both ends of the panel. When cutting lengthwise, use a table saw with a guide for better cut precision.

### STEP 11

Finally, place the cut pieces from the bottom moving upwards, attaching each panel with nails, glue and screws. The panels can be complemented with available moldings:

- Edge Trim
- Baseboard
- Exterior Corner
- Inside Corner

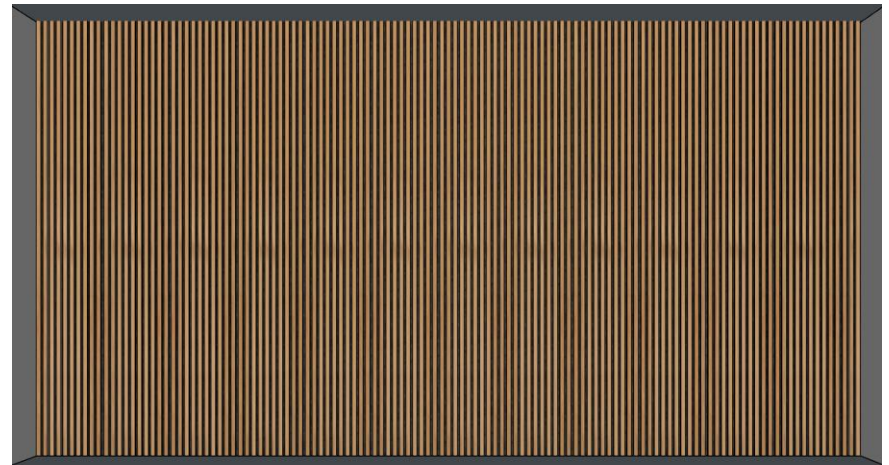

---

# **HORIZONTAL INSTALLATION**

---

# INTERVALS WALL PANEL INSTALLATION GUIDELINES

## STEP 1

Ensure your application wall is level and plumb. If discrepancies in height or width exist, adjust your layout accordingly.

Correct any surface irregularities in the installation area that could affect panel placement.

Intervals wall panels are suitable for most flat, smooth surfaces, including plywood and gypsum.

Like all natural wood, Intervals may expand and contract. To accommodate this, paint the wall behind the panels in flat black. This helps minor gaps from expansion or contraction appear as shadows, ensuring a seamless look.

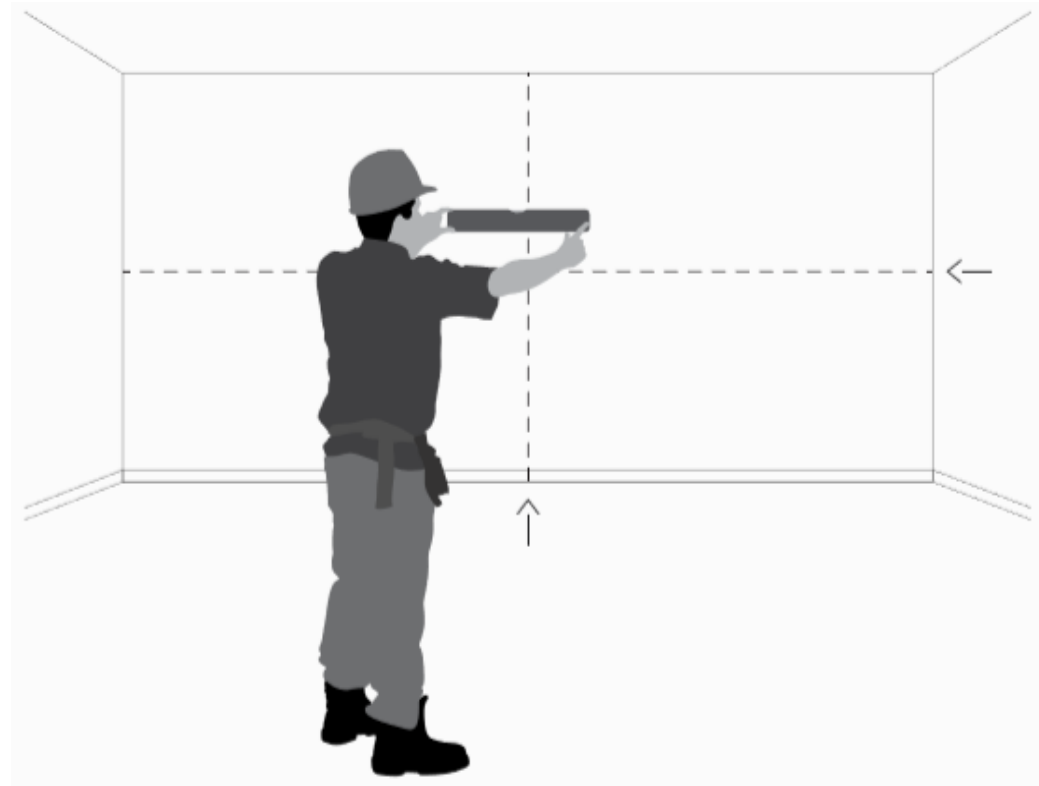

# INTERVALS WALL PANEL INSTALLATION GUIDELINES

## STEP 2

Measure the area where the Intervals panels will be installed. After obtaining the dimensions, lay the panels on a flat floor for pre-assembly and mark the cuts you will need.

TOOLS: CHALK LINE & MEASURING TAPE

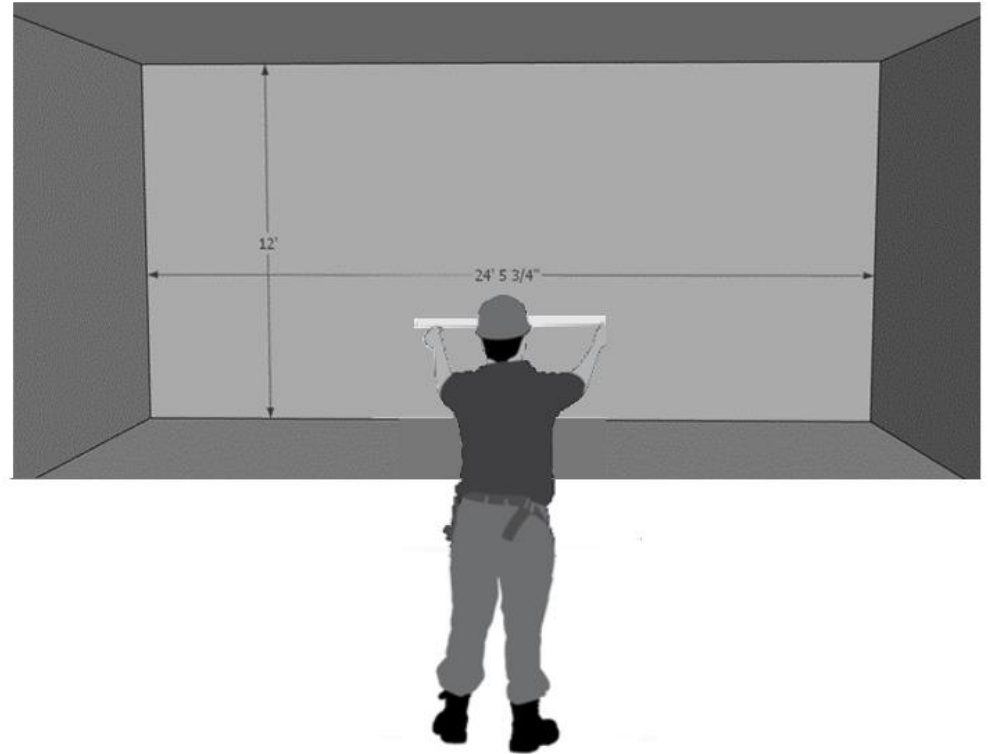

## INTERVALS WALL PANEL INSTALLATION GUIDELINES

### STEP 3

Peel off the protective paper from the adhesive. Be careful not to leave paper waste.

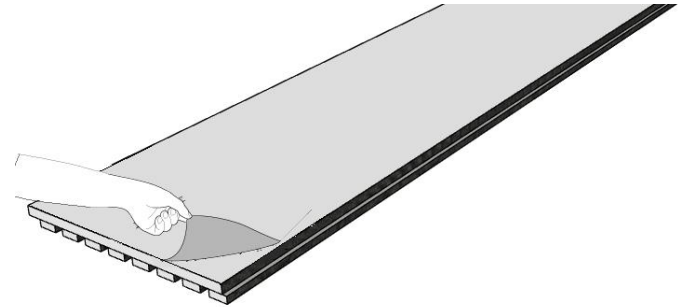

### STEP 4

Add adhesive on the back of the panel and place the initial panel at the starting point of the installation.

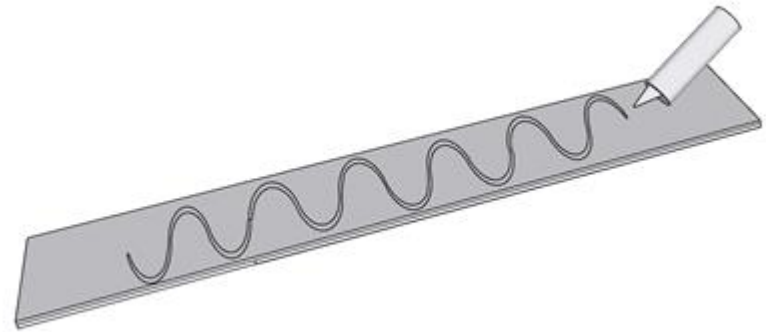

## INTERVALS WALL PANEL INSTALLATION GUIDELINES

### STEP 5

Apply pressure on the individual piece when nailing and inserting the screws.

Using 18 Gauge Nails and 1" black screws, nail along the panel, making sure you will be able to hide the black screws with the overlap of the next panel.

When possible, do not nail on the face of the slats, try to nail the felt or the lower edge of the veneer to maintain the finished aesthetic of the wall covering.

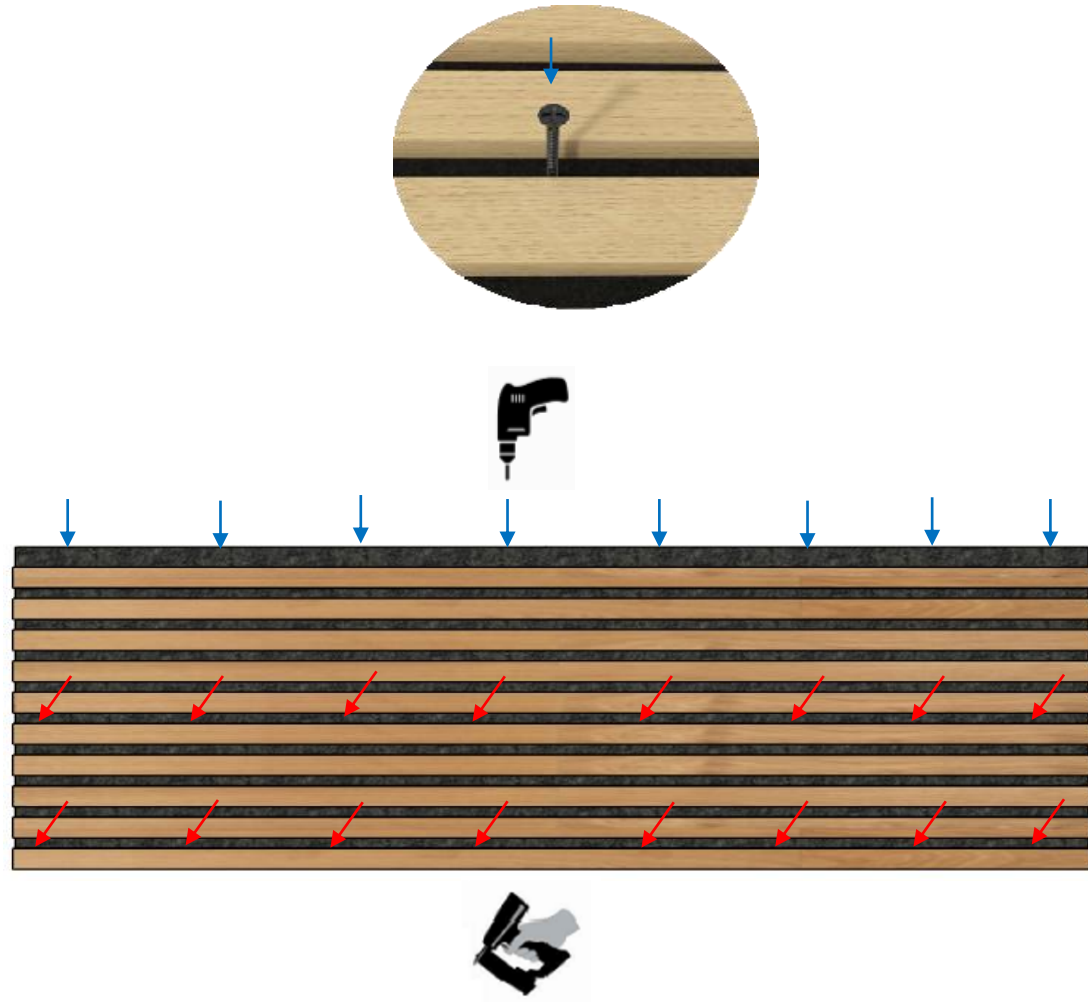

## INTERVALS WALL PANEL INSTALLATION GUIDELINES

### STEP 6

It is recommended to define and mark initial cuts before starting the installation.

Assemblies can start from bottom to top or top to bottom, you just need to rotate the panel to make sure the next panel will be able to overlap the screws of the initial panel.

### STEP 7

Affix the second piece with glue and nails, overlapping the screws from the previous panel. When starting the next row, use a rubber mallet for adjustments while the glue is still wet, ensuring the piece fits snugly into the overlap. Verify that there are no gaps between the pieces.

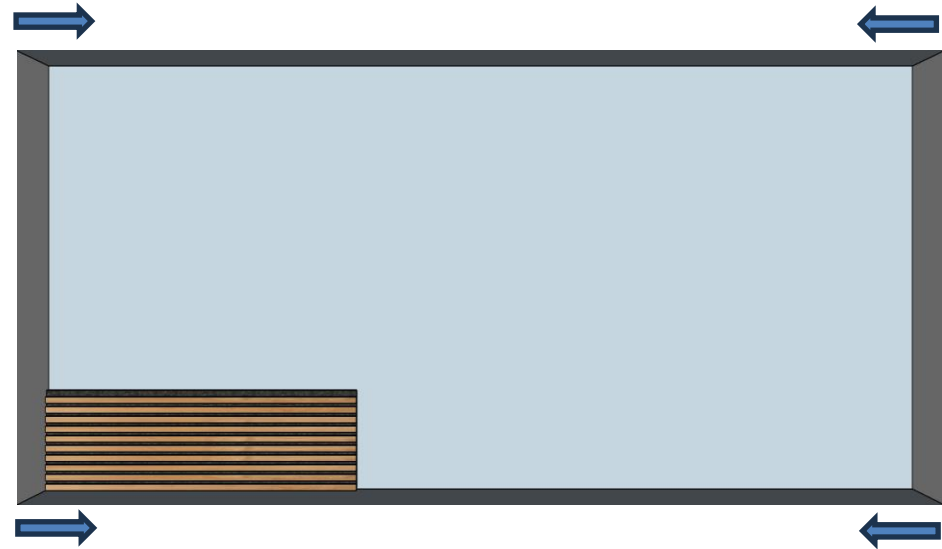

## INTERVALS WALL PANEL INSTALLATION GUIDELINES

### STEP 8

To cut the panels, mark the measurements on both ends of the panel. When cutting lengthwise, use a table saw with a guide for better cut precision.

### STEP 9

Affix the next piece with glue and nails, using a rubber mallet for adjustments while the glue is still wet. Verify that there are no gaps between the pieces.

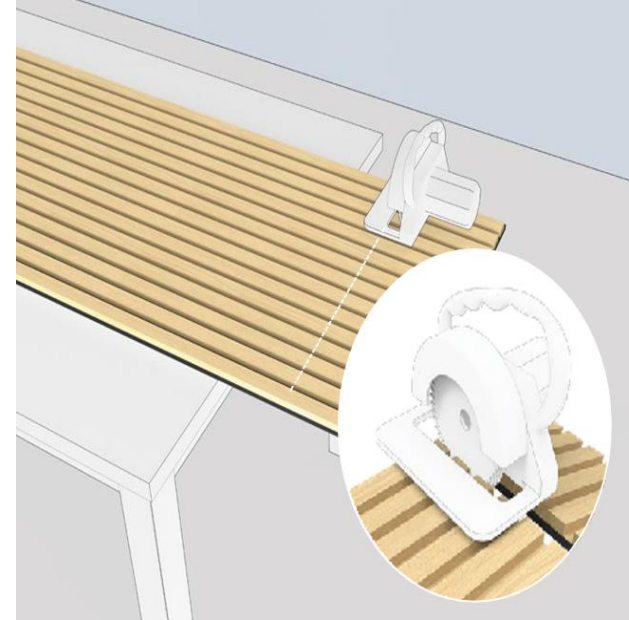

## INTERVALS WALL PANEL INSTALLATION GUIDELINES

### STEP 10

Repeat this fastening process across the wall, ensuring careful attention to the joints, fixation with the nails and screws, and alignment.

### STEP 11

Make sure to measure carefully and cut any panels to fit as you approach the end of the wall.



## INTERVALS WALL PANEL INSTALLATION GUIDELINES

### STEP 12

To cut the panels you must mark the measurements at the two ends of the panel.

When cutting lengthwise, use a table saw with a guide for better cut precision.

### STEP 13

Finally, place the cut pieces from the bottom moving upwards, attaching each panel with nails, glue and screws.

The panels can be complemented with available moldings:

- Edge Trim
- Baseboard
- Exterior Corner
- Inside Corner

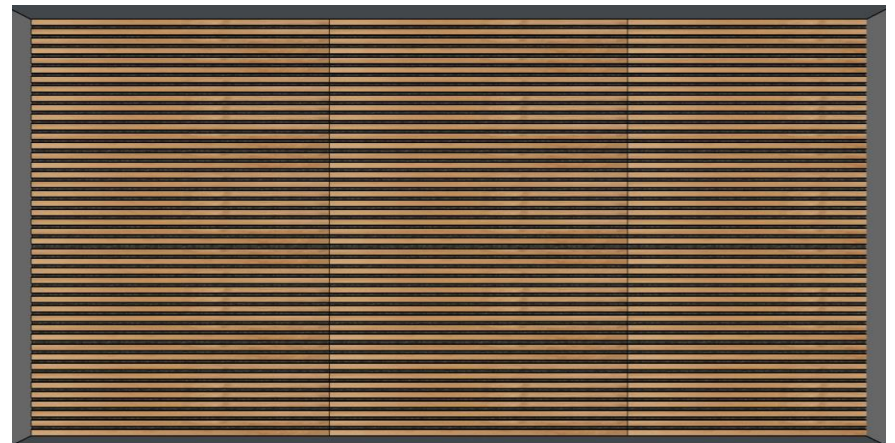

---

# **CEILING INSTALLATION**

---

# INTERVALS WALL PANEL INSTALLATION GUIDELINES

## STEP 1

Ensure your application ceiling is level and plumb. If discrepancies in length or width exist, adjust your layout accordingly.

Correct any surface irregularities in the installation area that could affect panel placement.

Intervals wall panels are suitable for most flat, smooth surfaces, including plywood and gypsum.

Like all natural wood, Intervals may expand and contract. To accommodate this, paint the ceiling behind the panels in flat black. This helps minor gaps from expansion or contraction appear as shadows, ensuring a seamless look.

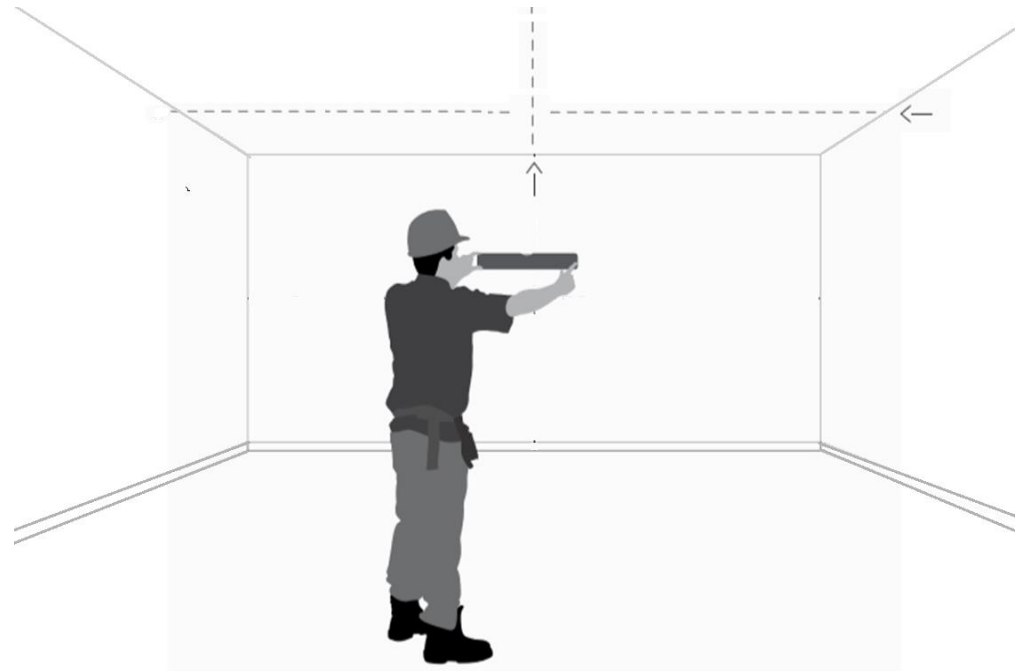

## INTERVALS WALL PANEL INSTALLATION GUIDELINES

### STEP 2

Measure the area where the Intervals panels will be installed. After obtaining the dimensions, lay the panels on a flat floor for pre-assembly and mark the cuts you will need.

TOOLS: CHALK LINE & MEASURING TAPE

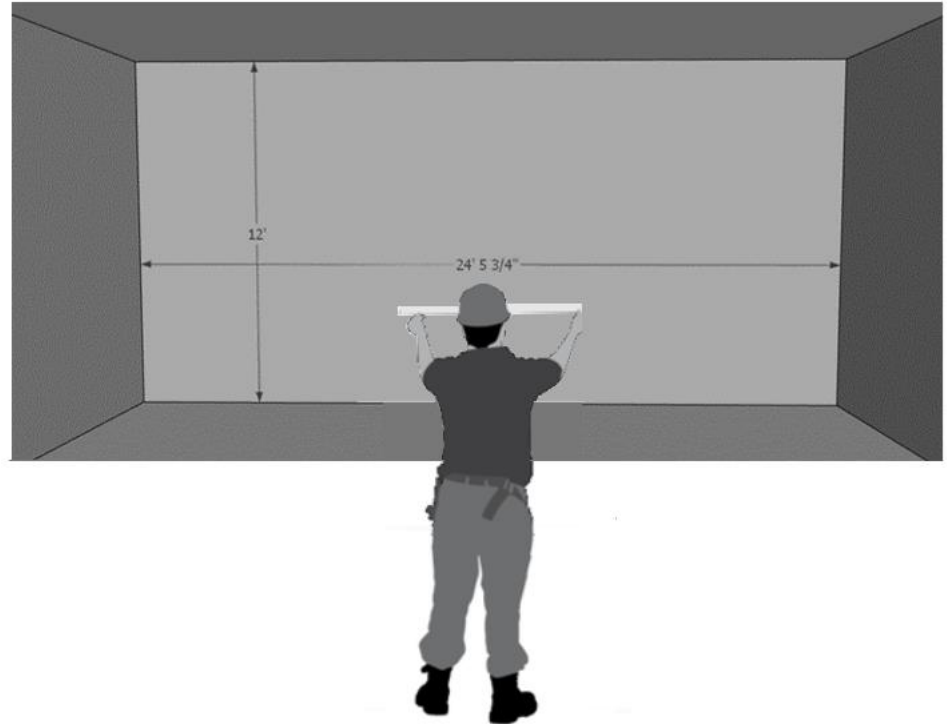

## INTERVALS WALL PANEL INSTALLATION GUIDELINES

### STEP 3

Peel off the protective paper from the adhesive. Be careful not to leave any paper waste.

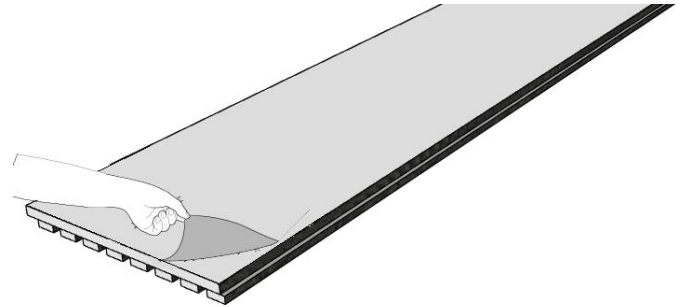

### STEP 4

Add adhesive on the back of the Intervals panel and place the initial panel at the starting point of the installation.

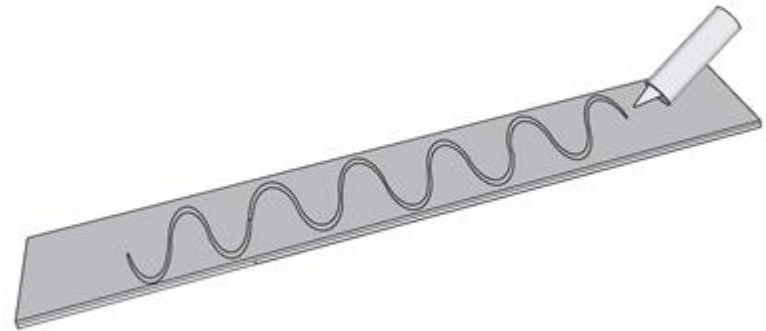

## INTERVALS WALL PANEL INSTALLATION GUIDELINES

### STEP 5

Apply pressure on the individual piece when nailing and inserting the screws. Attach outer edge screws first

Using 18 Gauge Nails and 1" black screws, nail along the panel, making sure you will be able to hide the black screws with the overlap of the next panel.

When possible, do not nail on the face of the slats, try to nail the felt or the lower edge of the veneer to maintain the finished aesthetic of the wall covering.

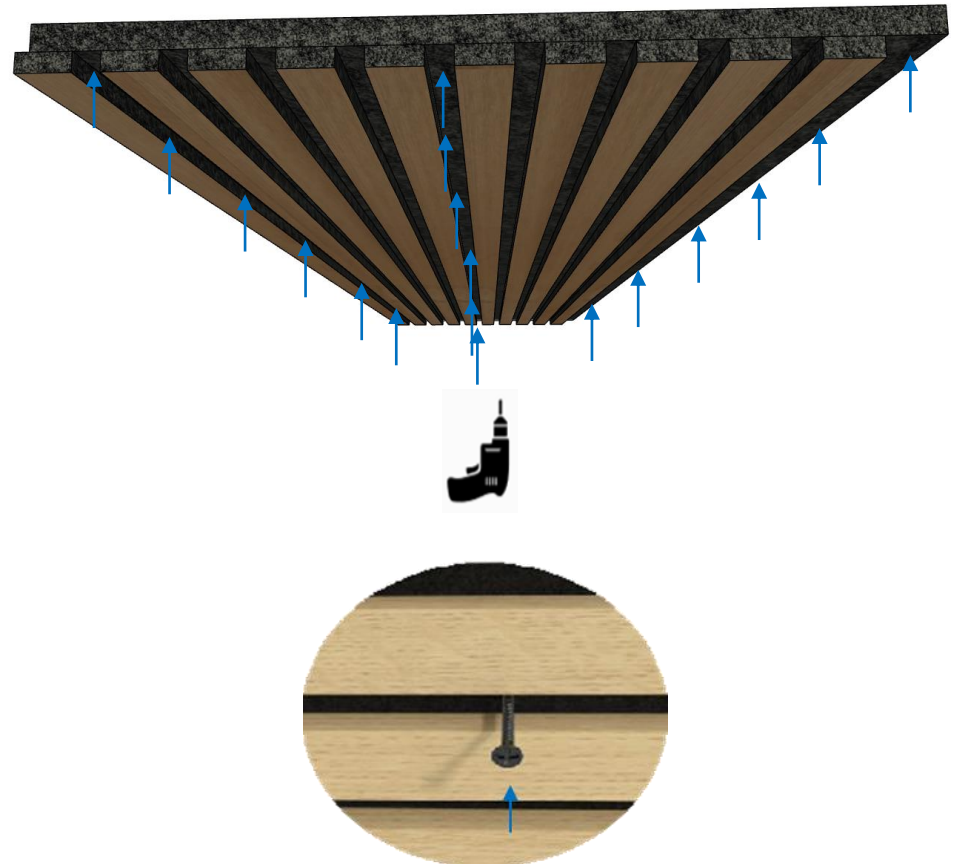

## INTERVALS WALL PANEL INSTALLATION GUIDELINES

### STEP 6

It is recommended to define and mark initial cuts before starting the installation.

Assemblies can start from left to right or right to left, you just need to rotate the panel to make sure the next panel will be able to overlap the screws of the initial panel.

In a ceiling application, it is important to note the direction you want to go.

### STEP 7

Affix the second piece with glue and nails overlapping the screws from the previous panel. When starting the next row, use a rubber mallet for adjustments while the glue is still wet, ensuring the piece fits snugly into the overlap. Verify that there are no gaps between the pieces.

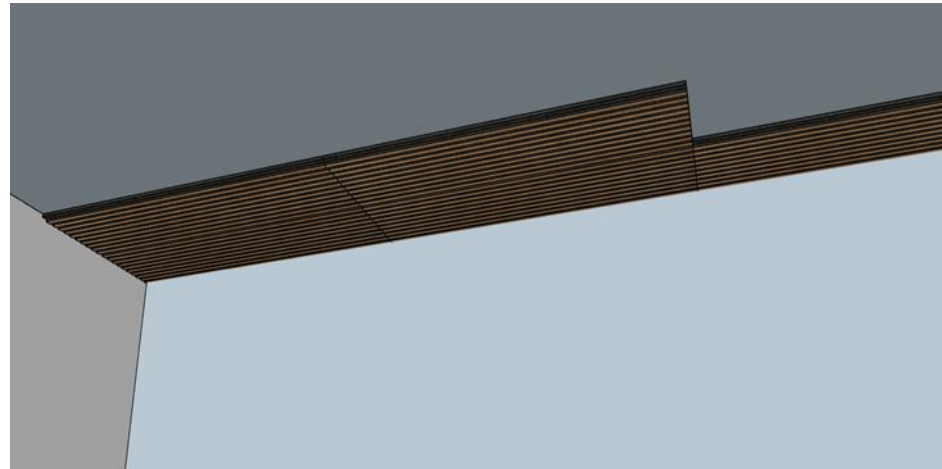
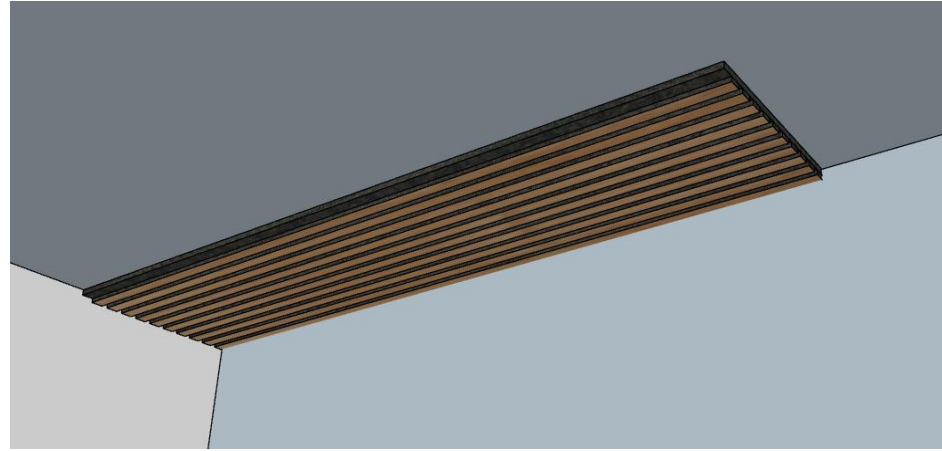

## INTERVALS WALL PANEL INSTALLATION GUIDELINES

### STEP 8

To cut the panels, mark the measurements on both ends of the panel. When cutting lengthwise, use a table saw with a guide for better cut precision.

### STEP 9

Affix the next piece with glue and nails, using a rubber mallet for adjustments while the glue is still wet. Verify that there are no gaps between the pieces.

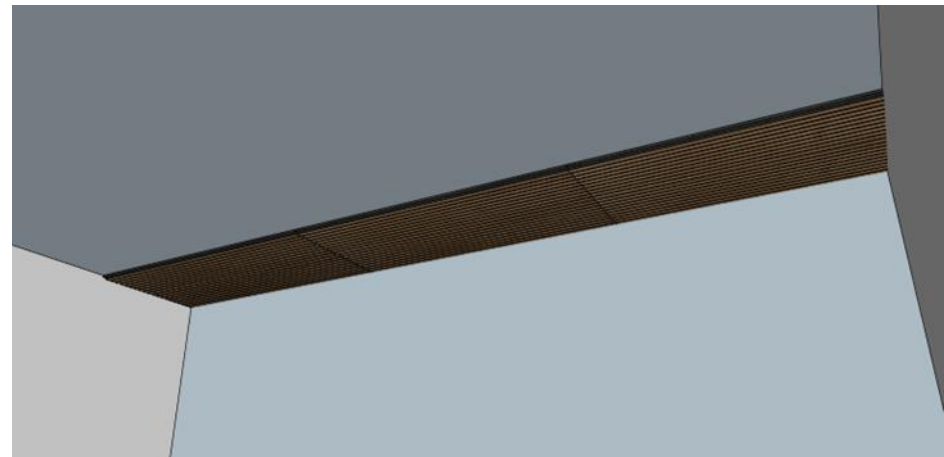
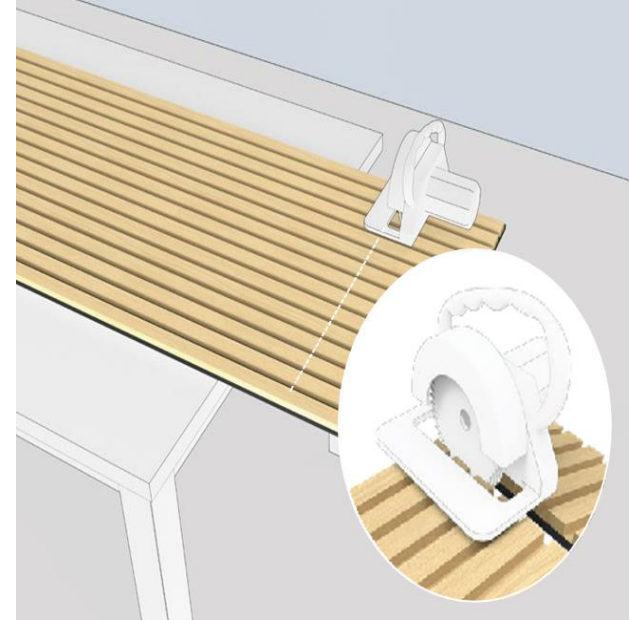

## INTERVALS WALL PANEL INSTALLATION GUIDELINES

### STEP 10

Make sure to measure carefully and cut any panels to fit as you approach the end of the ceiling.

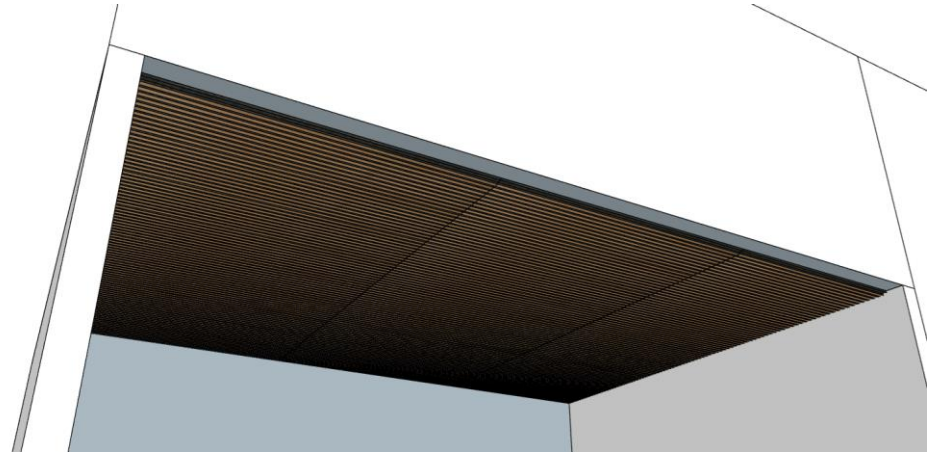

### STEP 11

Finally, place the cut pieces from the bottom moving upwards, attaching each panel with nails, glue and screws.

The panels can be complemented with available moldings:

- Edge Trim
- Baseboard
- Exterior Corner
- Inside Corner

